



VENUE
DECK

LIBU
ARM

EDEN ROC
MIAMI BEACH

NOBU HOTEL
MIAMI BEACH

EDEN ROC

MIAMI BEACH

ERC BALLROOMS & II

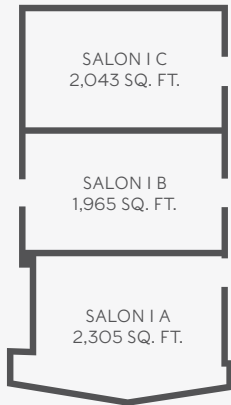

ERC I
LOBBY LEVEL



ERC II
UPPER LEVEL

ROOM NAME	Actual Sq. Ft.	Actual Sq. Mt.	L	W	Ceiling Height	Ceiling Height Mt.	60" Round 8-Plated	66" Round 10-Plated	72" Round 11-Plated	Meeting - Cres. Rds 6	Meeting - Cres. Rds 8	Theater	Class 2per6	Class MAX	Recept.	Conf	Ushape
ERC I	6,313	586.5	120	55	15	1.39	496	500	492	372	400	730	282	434	744	120	152
Salon I A	2,305	214.1	45	59	15	1.39	176	200	204	132	160	264	102	146	264	40	52
Salon I B	1,965	182.6	37	56	15	1.39	160	150	120	90	120	226	90	144	240	40	48
Salon I C	2,043	189.8	37	56	15	1.39	160	150	168	90	120	240	90	144	240	40	52
Salon I AB	4,270	396.7	82	60	15	1.39	320	280	300	144	192	490	192	290	504	80	100
Salon I BC	4,009	372.4	75	56	15	1.39	248	200	192	124	160	466	180	288	480	80	100
ERC I Foyer	2,712	252.0	30	145	12	1.11	-	-	-	-	-	-	-	-	100	-	-
ERC II	7,850	729.3	140	72	18	1.67	512	500	504	288	384	806	288	488	806	112	120
Salon II A	3,224	299.5	58	72	18	1.67	176	200	252	96	160	276	102	171	291	40	56
Salon II B	2,268	210.7	41	61	18	1.67	160	150	120	96	120	220	98	156	220	40	52
Salon II C	2,357	219.0	41	61	18	1.67	176	150	120	96	120	220	98	156	220	40	52
Salon II AB	5,493	510.3	99	72	18	1.67	244	300	300	168	224	480	208	296	480	72	88
Salon II BC	4,625	429.7	82	61	18	1.67	200	250	240	150	200	350	160	210	506	72	84
ERC II Foyer	3,063	284.6	53	157	10	0.93	-	-	-	-	-	-	-	-	230	-	-



EDEN ROC
MIAMI BEACH



MONA
LISA

ROOM NAME	Actual Sq. Ft.	Actual Sq. Mt.	L	W	Ceiling Height	Ceiling Height Mt.	60" Round 8-Plated	66" Round 10-Plated	72" Round 11-Plated	Meeting - Cres. Rds 6	Meeting - Cres. Rds 8	Theater	Class 2per6	Class MAX	Recept.	Conf	Ushape
Mona Lisa	4,607	428	70	73	12	1.11	240	260	312	144	208	364	112	168	364	30	33



EDEN ROC
MIAMI BEACH

POMPEII
BALLROOM

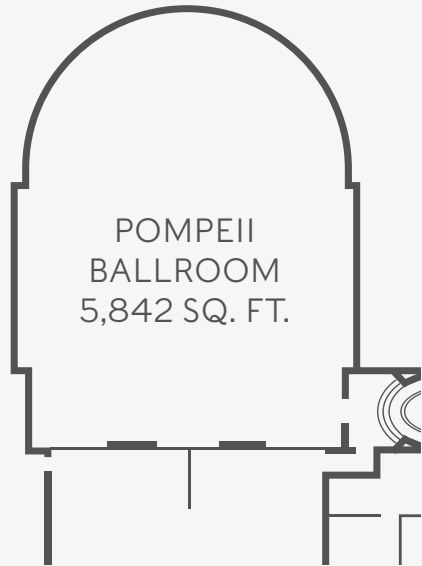

ROOM NAME	Actual Sq. Ft.	Actual Sq. Mt.	L	W	Ceiling Height	Ceiling Height Mt.	60" Round 8-Plated	66" Round 10-Plated	72" Round 11-Plated	Meeting - Cres. Rds 6	Meeting - Cres. Rds 8	Theater	Class 2per6	Class MAX	Recept.	Conf	Ushape
Pompeii Ballroom	5,842	542.7	112	66	18	1.7	336	380	420	306	248	675	256	305	675	64	88



EDEN ROC
MIAMI BEACH

PROMENADE
ROOM



ROOM NAME	Actual Sq. Ft.	Actual Sq. Mt.	L	W	Ceiling Height	Ceiling Height Mt.	60" Round 8-Plated	66" Round 10-Plated	72" Round 11-Plated	Meeting - Cres. Rds 6	Meeting - Cres. Rds 8	Theater	Class 2per6	Class MAX	Recept.	Conf	Ushape
Promenade	3,138	291.5	58	57	9	0.8	184	230	216	138	184	275	110	156	275	28	-
Promenade A	1,418	131.7	56	27	9	0.8	80	100	96	60	80	126	50	65	126	36	33
Promenade B	1,703	158.2	56	31	9	0.8	104	130	120	78	96	156	60	90	156	44	40



EDEN ROC
MIAMI BEACH



SPA
GARDEN

ROOM NAME	Actual Sq. Ft.	Actual Sq. Mt.	L	W	Ceiling Height	Ceiling Height Mt.	60" Round 8-Plated	66" Round 10-Plated	72" Round 11-Plated	Meeting - Cres. Rds 6	Meeting - Cres. Rds 8	Theater	Class 2per6	Class MAX	Recept.	Conf	Ushape
Spa Garden	3,568	331.5	-	-	-	-	168	200	228	-	-	-	-	-	250	-	-

*INDOOR BACK UP PROVIDED



EDEN ROC
MIAMI BEACH

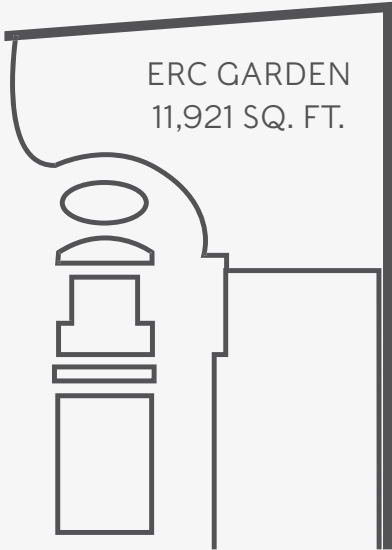

ERC
GARDEN

ROOM NAME	Actual Sq. Ft.	Actual Sq. Mt.	L	W	Ceiling Height	Ceiling Height Mt.	60" Round 8-Plated	66" Round 10-Plated	72" Round 11-Plated	Meeting - Cres. Rds 6	Meeting - Cres. Rds 8	Theater	Class 2per6	Class MAX	Recept.	Conf	Ushape
ERC Garden	11,921	1107.5	-	-	-	-	448	560	672	-	-	-	-	-	1500	-	-
ERC Garden A	4,000	371.6	-	-	-	-	160	200	240	-	-	-	-	-	500	-	-
ERC Garden B	4,000	371.6	-	-	-	-	160	200	240	-	-	-	-	-	500	-	-
ERC Garden C	4,000	371.6	-	-	-	-	128	160	192	-	-	-	-	-	500	-	-
ERC Garden AB	8,000	743.2	-	-	-	-	320	400	480	-	-	-	-	-	1000	-	-



EDEN ROC
MIAMI BEACH

PALLADIUM POOL TERRACE
2,500 SQ. FT.

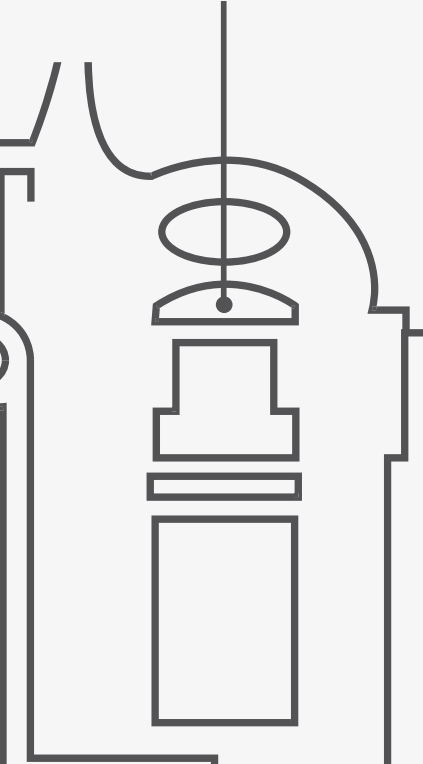

PALLADIUM POOL TERRACE

OUTDOOR EVENT SPACE - OUTDOOR TERRACE



EDEN ROC
MIAMI BEACH

SEABREEZE / SPA
TERRACE



ROOM NAME	Actual Sq. Ft.	Actual Sq. Mt.	L	W	Ceiling Height	Ceiling Height Mt.	60" Round 8-Plated	66" Round 10-Plated	72" Round 11-Plated	Meeting - Cres. Rds 6	Meeting - Cres. Rds 8	Theater	Class 2per6	Class MAX	Recept.	Conf	Ushape
Seabreeze/Spa Terrace	3,490	324.2	-	-	-	-	80	80	96	-	-	-	-	-	250	-	-



EDEN ROC
MIAMI BEACH

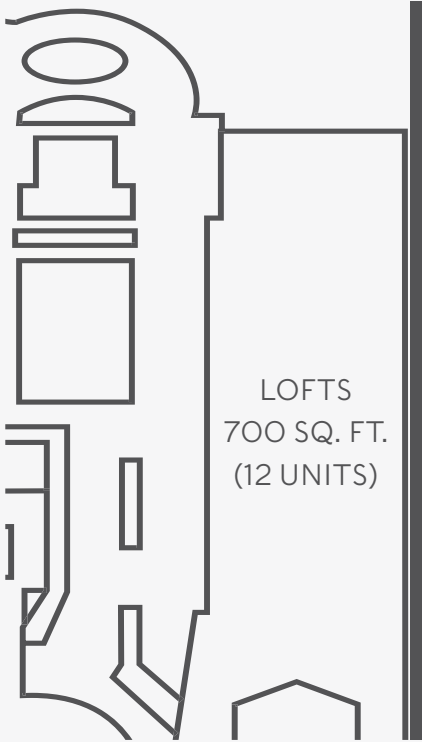

LOFT

INDOOR EVENT SPACE

*INCLUDES REMOVAL OF FURNITURE



EDEN ROC

MIAMI BEACH

CONFERENCE CENTER

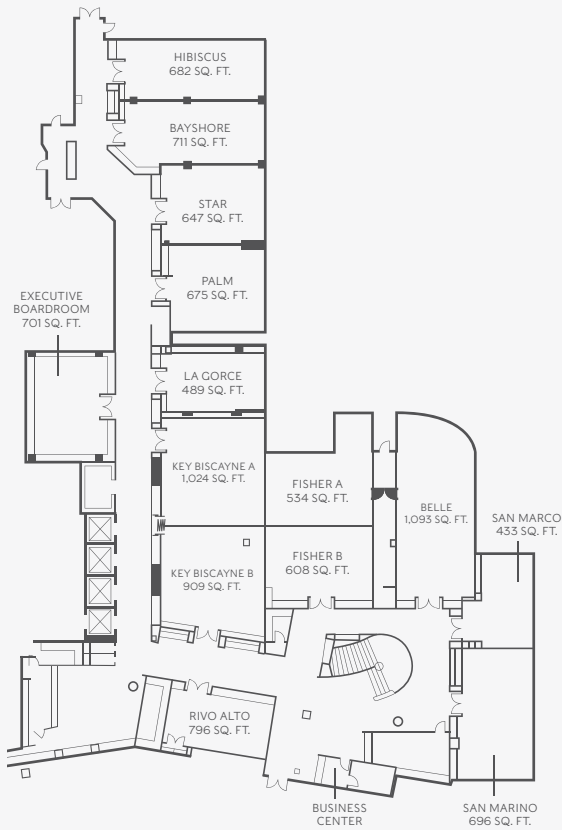

ROOM NAME	Actual Sq. Ft.	Actual Sq. Mt.	L	W	Ceiling Height	Ceiling Height Mt.	60" Round 8-Plated	66" Round 10-Plated	72" Round 11-Plated	Meeting - Cres. Rds 6	Meeting - Cres. Rds 8	Theater	Class 2per6	Class MAX	Recept.	Conf	Ushape
Bayshore Room	711	66.1	39	19	8	0.7	64	60	60	48	48	70	24	36	72	26	28
Belle	1,093	101.5	49	27	7.3	0.7	56	70	72	42	56	95	42	55	112	26	25
Executive Boardroom	701	65.1	26	32	8	0.7	-	-	-	-	-	-	-	-	-	20	-
Fisher	1,142	106.1	49	30	7.3	0.7	64	70	72	48	56	90	32	48	96	-	-
Fisher A	534	49.6	21	28	7.3	0.7	32	30	24	24	24	40	20	30	46	20	20
Fisher B	608	56.5	28	30	7.3	0.7	24	30	24	18	24	35	14	21	40	20	18
Hibiscus Room	682	63.4	40	17	8	0.7	48	50	48	18	24	72	28	42	72	30	28
Key Biscayne Room	1,933	179.6	69	31	8	0.7	112	110	108	84	80	160	80	123	160	52	52
Key Biscayne A	1,024	95.1	36	31	8	0.7	56	60	72	42	48	90	40	60	98	24	32
Key Biscayne B	909	84.4	34	31	8	0.7	40	50	48	30	40	84	32	48	84	24	24
La Gorce Room	489	45.4	28	17	8	0.7	24	30	36	18	24	30	16	24	35	18	16
Palm Room	675	62.7	28	25	8	0.7	40	40	36	30	32	60	32	36	60	20	22
Rivo Alto	796	74.0	39	17	8	0.7	40	50	48	30	40	56	20	30	56	26	26
San Marco	433	40.2	24	17	8.5	0.8	16	20	12	12	16	20	12	18	25	16	14
San Marino	696	64.7	21	31	8.6	0.8	40	40	36	30	32	60	24	36	68	24	25
Star Room	647	60.1	28	22	8	0.7	50	40	36	18	32	40	32	36	58	20	22



NOBU HOTEL
MIAMI BEACH

TSUKI

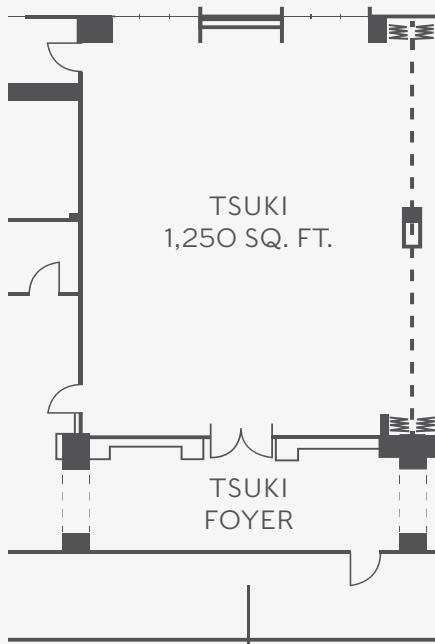

TSUKI TERRACE
320 SQ. FT.

ROOM NAME	Actual Sq. Ft.	Actual Sq. Mt.	L	W	Ceiling Height	Ceiling Height Mt.	60" Round 8-Plated	66" Round 10-Plated	72" Round 11-Plated	Meeting - Cres. Rds 6	Meeting - Cres. Rds 8	Theater	Class 2per6	Class MAX	Recept.	Conf	Ushape
Tsuki	1,250	116.1	30	41	8.2	0.8	48	-	-	36	48	70	30	45	60	20	20
Tsuki Terrace	320	29.7	40	8	-	-	-	-	-	-	-	-	-	-	-	-	-



NOBU HOTEL
MIAMI BEACH

A O Z O R A

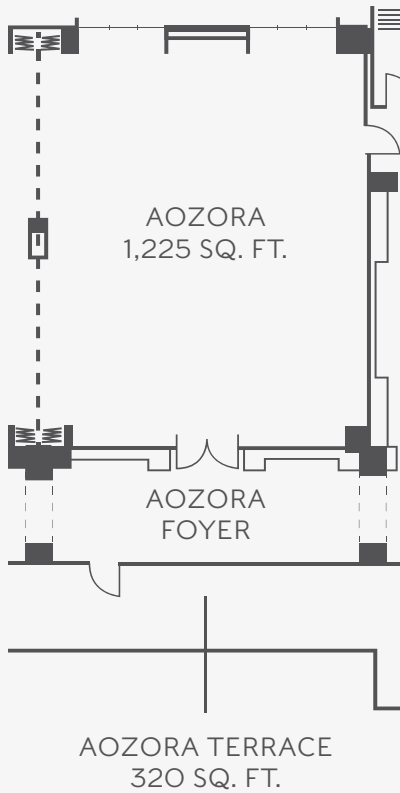

ROOM NAME	Actual Sq. Ft.	Actual Sq. Mt.	L	W	Ceiling Height	Ceiling Height Mt.	60" Round 8-Plated	66" Round 10-Plated	72" Round 11-Plated	Meeting - Cres. Rds 6	Meeting - Cres. Rds 8	Theater	Class 2per6	Class MAX	Recept.	Conf	Ushape
Aozora	1,225	113.8	30	41	8.2	0.8	48	-	-	36	48	70	30	45	60	20	20
Aozora Terrace	320	29.7	40	8	-	-	-	-	-	-	-	-	-	-	-	-	-



NOBU HOTEL
MIAMI BEACH

TSUKI & AOZORA

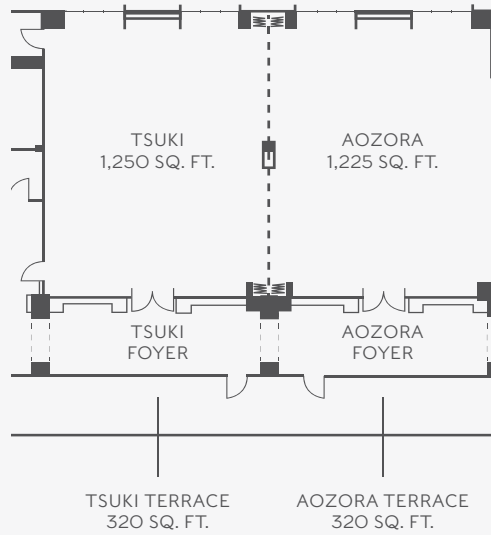

ROOM NAME	Actual Sq. Ft.	Actual Sq. Mt.	L	W	Ceiling Height	Ceiling Height Mt.	60" Round 8-Plated	66" Round 10-Plated	72" Round 11-Plated	Meeting - Cres. Rds 6	Meeting - Cres. Rds 8	Theater	Class 2per6	Class MAX	Recept.	Conf	Ushape
Tsuki & Aozora	2,460	228.5	30	82	8.2	0.8	96	-	-	72	96	140	60	90	120	40	40



NOBU HOTEL
MIAMI BEACH

TAIYO

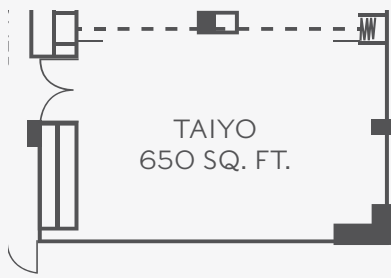

ROOM NAME	Actual Sq. Ft.	Actual Sq. Mt.	L	W	Ceiling Height	Ceiling Height Mt.	60" Round 8-Plated	66" Round 10-Plated	72" Round 11-Plated	Meeting - Cres. Rds 6	Meeting - Cres. Rds 8	Theater	Class 2per6	Class MAX	Recept.	Conf	Ushape	
Taiyo	650	60.4	21	32	8.2	0.8	48											
Taiyo Terrace	511	47.5	37	13	-	-	-	40										

EXISTING LOUNGE FURNITURE FOR 16 PEOPLE



NOBU HOTEL
MIAMI BEACH

MIZU

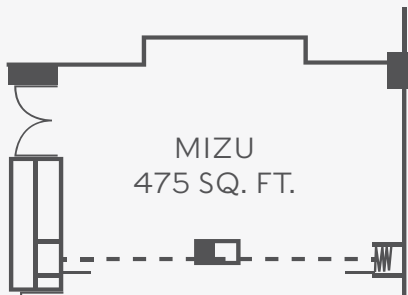

ROOM NAME	Actual Sq. Ft.	Actual Sq. Mt.	L	W	Ceiling Height	Ceiling Height Mt.	60" Round 8-Plated	66" Round 10-Plated	72" Round 11-Plated	Meeting - Cres. Rds 6	Meeting - Cres. Rds 8	Theater	Class 2per6	Class MAX	Recept.	Conf	Ushape
Mizu	475	44.1	23	32	8.2	0.8				BOARDROOM EXISTING SETUP FOR 14 PEOPLE							



EDEN ROC
MIAMI BEACH

NOBU HOTEL
MIAMI BEACH

ER-SALES@NOBUEDENROC.COM

EDENROCMIAMIBEACH.COM | NOBUHOTELMIAMIBEACH.COM